

# Breaker for TRV

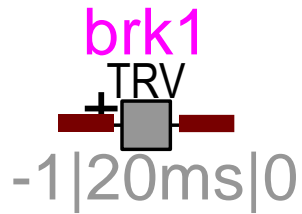

Breaker for TRV .....	1
1 Available versions .....	1
2 Description .....	1
3 Parameters and rules.....	1
3.1 Data tab .....	1
3.2 Random data tab .....	3
3.3 TRV data tab.....	3
3.4 Scopes tab.....	7
3.5 Observe tab .....	7
4 Rules .....	7
5 Steady-state model and initial conditions .....	7
6 Frequency Scan model.....	7
7 Time-domain model .....	7
8 References.....	7

Henry Gras, Jean Mahseredjian, Jesus Morales 2021-08-17 15:35:00

## 1 Available versions

This device is 3-phase. The 3-phase version of this device is the equivalent of 3 independent 1-phase devices with separate data.

This device uses subcircuits and can be modified by users if required.

## 2 Description

This device is a breaker modelled by ideal switches. It has a zero resistance (zero voltage drop) when closed and infinite resistance when open.

This device has random data capability like in the case of an Ideal switch.

It is intended to be used for Transient Recovery Voltage (TRV) analysis.

The voltage withstand of the breaker gap can be drawn and prestrikes, restrikes or reignitions simulated. Parameters of rated TRV from IEC and IEEE standards are available (see [1]-[5]). Rated TRVs are harmonized in IEC and ANSI standards.

## 3 Parameters and rules

### 3.1 Data tab

See documentation of Ideal switch.

The random numbers used for switching times during statistical studies are generated by an ideal switch located inside the Breaker for TRV subcircuit, inside a device named 'T'. The ideal switch name is sw. Therefore, if the Breaker for TRV has slaves, in addition to the path of the device, '/T/sw' has to be added in the slave dependency input fields.

- Dependency** is used to create random data dependency. The same rules as for ideal switches apply.

❑ **Reference switch name** is the ideal switch the current Breaker for TRV depends on when it is not a Master. Clicking on the hyperlink provides rules for naming the reference switch.

For example, in the design of the Figure 3-1, *brk1* is the slave of fault. Figure 3-2 shows how to set the dependency of the phase A of *brk1* to be slave of fault, and of the phases B and C to be the slaves of phase A.

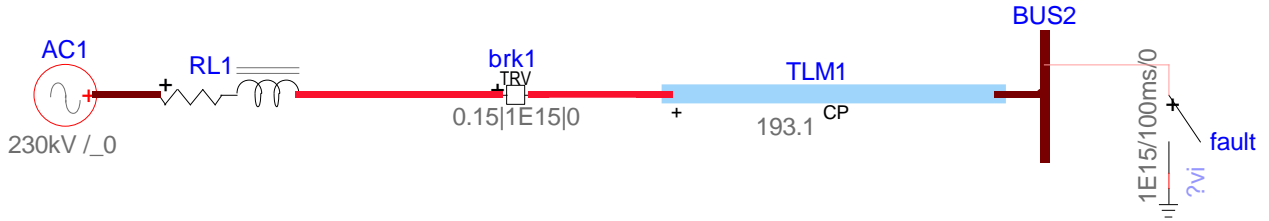

**Figure 3-1: Master/Slave between Breaker for TRV and ideal switch**

<b>Phase A Random data law</b>	Gaussian
Dependency	Slave
Reference switch name	fault
Random	Closing time
Mean of delay	80 ms
Standard deviation of delay	.001 s
Number of steps	5
<b>Phase B Random data law</b>	Gaussian
Dependency	Slave
Reference switch name	brk1a
Random	Closing time
Mean of delay	0 ms
Standard deviation of delay	.001 s
Number of steps	5
<b>Phase C Random data law</b>	Gaussian
Dependency	Slave
Reference switch name	brk1a
Random	Closing time
Mean of delay	0 ms
Standard deviation of delay	.001 s
Number of steps	5

**Figure 3-2: Random data tab of brk1, slave of fault**

Figure 3-3 shows another example of reference between Breakers for TRV. *brk1* is the slave of *brk2*. Figure 3-4 shows how to set the dependency of the phase A of *brk1* to be slave of phase A of *brk2*.

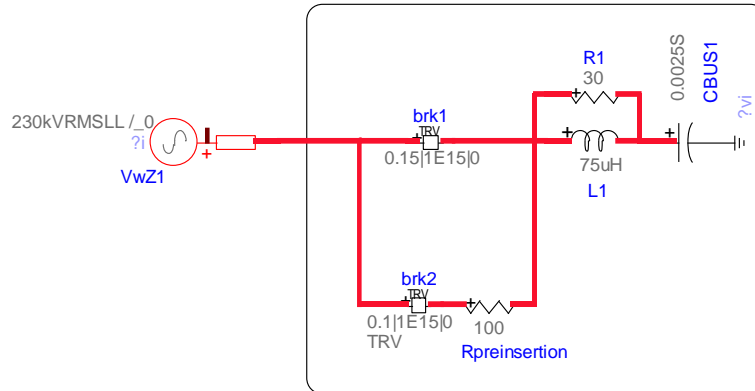

Figure 3-3: Master/Slave between Breakers for TRV

Phase A Random data law	Gaussian
Dependency	Slave
Reference switch name	brk2/T/swa
Random	Closing time
Mean of delay	8 ms
Standard deviation of delay	.001 s
Number of steps	5

Figure 3-4: Random data tab of brk1, slave of brk2

### 3.2 Random data tab

See documentation of Ideal switch.

### 3.3 TRV data tab

This tab contains options to display the Transient Recovery Voltage (TRV) rating of breaker, to enable restrikes/prestrikes and re-ignitions, and to include stray capacitances.

- **Draw rating TRV:** enables the TRV drawing in time-domain scopes and allows to enter options. Five TRV-scopes will become available for each phase under “control” Scope type (group), for example in the case of Brk1:
  - **Brk1/TRV/a/delay:** The delayed slope in Figure 3-5, for phase-a.
  - **Brk1/TRV/a/delay\_:** The negative of the above. Note that a polarity inversion may occur due to the opening instant of the breaker and that is why two scopes are available.
  - **Brk1/TRVa/envelope:** The envelope (4-parameter, 2-parameter, cosine or exponential-cosine) in Figure 3-5, for phase-a.
  - **Brk1/TRVa/envelope\_:** The negative of the above. Note that a polarity inversion may occur due to the opening instant of the breaker and that is why two scopes are available.
  - **Brk1/a/TRV\_exceeded:** becomes 1 when the TRV envelope is exceeded by actual breaker voltage. It is 0 or -1 otherwise.

The user may also select the breaker voltage scope (see Scopes tab) and compare it with the above plots.

- **Envelope:** select a **Standard** for pre-defined data or **User-defined** to use your own data.

❑ **Breaker class:**

Defined in [1] and [3]:

- **Class S1** for cables and **Class S2** for lines with a rated voltage below 100kV.
- **>100kV effectively earthed:** for breakers with a rated voltage higher than 100kV in an effectively earthed system.
- **>100kV non-effectively earthed:** for breakers with a rated voltage higher than 100kV in a non-effectively earthed system.

Defined in [4] and [5]:

- **Below 100kV, indoor:** for indoor breakers with a rated voltage below 100kV.
- **Below 100kV, outdoor:** for outdoor breakers with a rated voltage below 100kV.
- **100kV or above:** for breakers with a rated voltage higher than 100kV in a non-effectively earthed system.

Defined in [6]:

Machine rated power range:

- **10-50 MVA**
- **51-100 MVA**
- **100-400 MVA**
- **401-800 MVA**
- **Over 800 MVA**

The available options varied based on the standard selected.

- ❑ **Rated voltage:** Rated voltage of the circuit breaker in kV (RMS line-to-line). Value predefined in the standards [1] and [3] or [4] and [5].
- ❑ **Rated short-circuit current:** Symmetrical interrupting capability for three-phase faults (Rated short-circuit breaking current in IEC).
- ❑ **Rated TLF current:** Symmetrical interrupting capability for transformer-limited-fault as defined in IEEE C37.06.1.
- ❑ **Event preceding the TRV:** According to [1]-[3], the Rating TRV of a circuit-breaker depends on the type of event to clear and the current to interrupt. The parameters available in the current version of this device are for single-phase short-line, for terminal faults and for transformer limited-faults.
- ❑ **Type of fault:** Type of fault to clear. The breaker TRV parameters vary according to the type of fault.
- ❑ **Short-circuit current to clear:** Steady-state current of breaker before opening. Can be determined by simulating the event without opening the switch or in steady-state and looking at the current through the breaker. Used to interpolate the parameters from T10, T30, T60 and T100 (see [1]-[3]). The interpolation is done between 10 and 100% of the **Rated short-circuit current** following the chapter 6.104.5 of [1] and chapter 4.2.1 of [2]
- ❑ **Find Steady-State solution and fill the 'Short-circuit current to clear' input with the breaker current:** If this box is checked, the network Steady-State solution is calculated when the user presses "OK". The field '**Short-circuit current to clear**' is filled with the breaker current of the Steady-State solution and the TRV parameters are calculated with this value.
- ❑ **Run the time-domain simulation and plot the TRV waveforms:** If this box is checked, the time-domain simulation of the network is started when the user presses "OK". Once the simulation completed, the prospective and inherent TRV plots are shown.

The following table can be modified only if **Envelope** is set to **User-defined**. Otherwise it only displays the parameters predefined in standards [1]-[5].

- ❑ **TRV shape:** Select the shape of the TRV envelope. Four options are available: **2-parameter** and **4-parameter** as defined in [1] and **cosine** and **exponential-cosine** as defined in [5]. (see Figure 3-5).

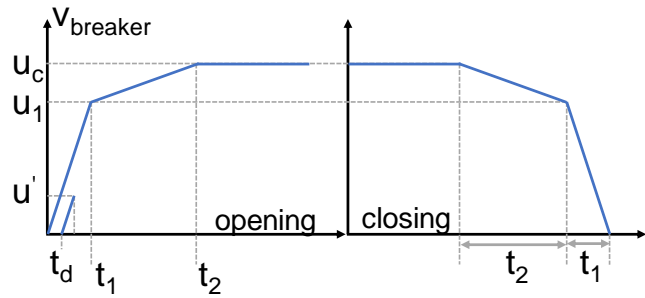

a) 4-parameter envelope

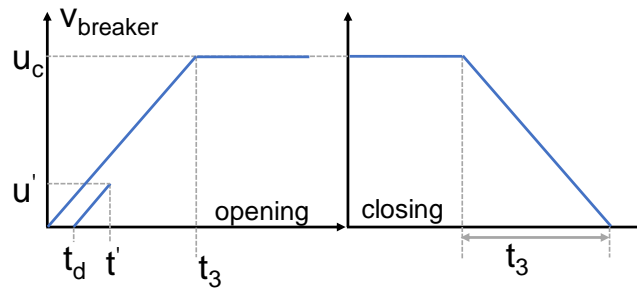

b) 4-parameter envelope

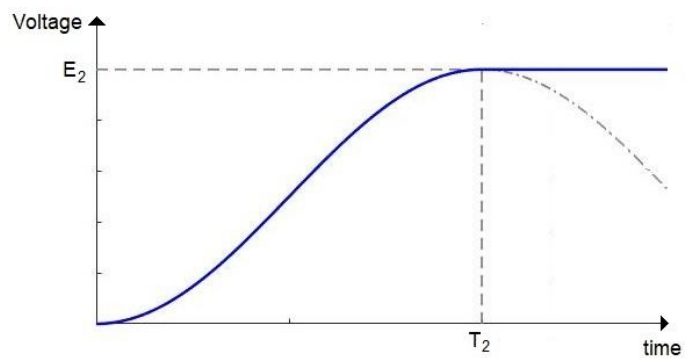

c) Cosine envelope

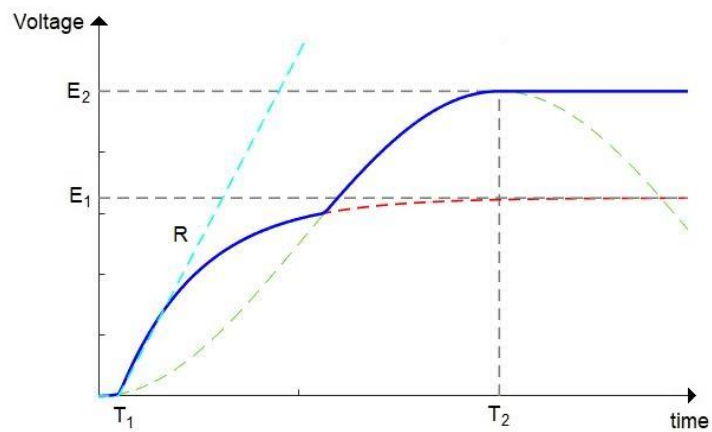

d) Exponential-cosine envelope

**Figure 3-5: 4-parameter, 2-parameter, cosine and exponential-cosine envelopes of TRV**

### Parameters for 4-parameters and 2-parameters envelopes:

- ❑ **kpp**: First-pole-to-clear factor.
- ❑ **kaf**: Amplitude factor.
- ❑ **u<sub>1</sub>**: 4-parameter envelope only. Value of the withstand voltage of the circuit breaker at time **t<sub>1</sub>** after the commencement of breaker opening.
- ❑ **u<sub>c</sub>**: Maximum value of the withstand voltage of the circuit breaker. Reached at **t<sub>2</sub>** for 4-parameter envelopes and at **t<sub>3</sub>** for 2-parameter envelopes.
- ❑ **t<sub>3</sub>**: used for **2-parameter** TRVs only.
- ❑ **t<sub>1</sub>**: used for **4-parameter** TRVs only.
- ❑ **t<sub>2</sub>**: used for **4-parameter** TRVs only.
- ❑ **RRRV1**: Rate of rise of recovery voltage. Used for **4-parameter** TRVs. It is the first slope of the rated TRV and calculated with **u<sub>1</sub>** and **t<sub>1</sub>**.
- ❑ **RRRV2**: Rate of rise of recovery voltage. Used for **2** and **4-parameter** TRVs. It is the second or only slope of the rated TRV. It is calculated with **u<sub>c</sub>** and **t<sub>3</sub>** (or **t<sub>2</sub>** for 4-parameter TRV).
- ❑ **t<sub>d</sub>**: time delay of TRV.
- ❑ **t'**: end of the delay characteristic.
- ❑ **u'**: peak voltage of the delay line.

### Parameters for cosine and exponential-cosine envelopes:

- ❑ **E<sub>2</sub>**: Rated peak voltage (kV) for cosine curve.
  - ❑ **T<sub>2</sub>**: Rated time to peak (μs) for cosine curve.
  - ❑ **E<sub>1</sub>**: Rated maximum voltage (kV) for exponential curve.
  - ❑ **T<sub>1</sub>**: Rated delay time (μs) for exponential curve.
  - ❑ **R**: Rated rate of rise (kV/ μs) for exponential curve.
- ❑ **Draw ITRV**: Use this option if the initial TRV is considered (see Figure 3-6). Generally less important for breakers rated under 100kV or under 25 kA short circuit rating. It is also usually not considered for dead-tank breakers, and for breakers in cable systems or GIS, because the ITRV rate of rise is proportional to the current and bus surge impedance, as well as the breaker stray capacitance.
- If the initial TRV is studied, it is important to model the bus-work between the breaker and the system or the first major busbar discontinuity with distributed parameter lines.
- **RRRV<sub>i</sub>**: Rate of Rise of the initial recovery voltage
  - **t<sub>i</sub>**: end of the ITRV characteristic
  - **u<sub>i</sub>**: peak voltage of ITRV

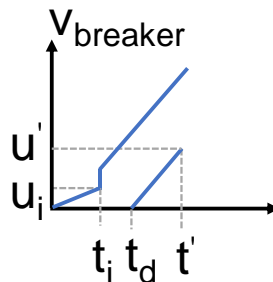

Figure 3-6 ITRV data input option

- ❑ **Enable Restrikes/prestrikes and re-ignitions:** enables the breaker conduction when its voltage withstand is reached. When the breaker is closing, if the voltage at the terminal of the breaker reaches the envelope of the voltage withstand (see Figure 3-5 closing part), the gap is closed and opened again when the current goes below  $I_{margin}$  (see Data tab).
- ❑ **Include stray capacitances:** when enabled, two stray capacitances, one on each side of each pole of the circuit breaker, are added.
- ❑ **Breaker type:** Type of breaker as defined in [2].
- ❑ **Stray capacitance k:** stray capacitance at the right pin k (+) of the breaker.
- ❑ **Stray capacitance m:** stray capacitance at the left pin of the breaker.

### 3.4 Scopes tab

See documentation of Ideal switch.

### 3.5 Observe tab

See documentation of Ideal switch.

## 4 Rules

It is not allowed to delete any pins.

This is an ideal device. Placing several breakers in parallel is acceptable if the breakers are not closed at the same time. When paralleled breakers are closed at the same time, mathematically impossible conditions will result and EMTP will *try* to solve such cases by inserting dummy resistances.

## 5 Steady-state model and initial conditions

If the breaker is closed in the steady-state solution ( $t_{close} < 0$ ), it is modeled as an ideal closed switch. It is an open-circuit otherwise.

## 6 Frequency Scan model

Similar to the steady-state.

## 7 Time-domain model

The breaker is modeled by zero resistance when conducting and by an infinite resistance when turned off.

## 8 References

- [1] IEC 62271-100. High-Voltage switchgear and control gear – Part 100: Alternating-current circuit-breaker. Edition 2.0, 2008-04
- [2] IEEE C37.011: Guide for the Application of transient Recovery Voltage for AC High-Voltage Circuit Breakers. IEEE Power & Energy Society, 2011.
- [3] IEEE C37.06: AC High-Voltage Circuit Breakers Rated on a Symmetrical Current Basis Preferred Ratings and Related Required Capabilities. IEEE Power & Energy Society, 2008.
- [4] IEEE C37.06: AC High-Voltage Circuit Breakers Rated on a Symmetrical Current Basis Preferred Ratings and Related Required Capabilities. ANSI, 2000.
- [5] IEEE C37.04: IEEE Standard Rating Structure for AC High-Voltage Circuit Breakers. IEEE Power Engineering Society, 1999 (R2006).
- [6] IEC/IEEE 62271-37-013: High-voltage switchgear and controlgear – Part 37-013: Alternating-current generator circuit-breakers, Edition 1.0 2015-10